

# Halo Circular

Design by Martín Azúa

A seamless merging of light and matter, Halo lends the effect of light floating in air. Powered by LED bulbs that remain invisible within their opalized, spherical moulds, the light flows freely from its source.

---

## Pendants



ø 55,5 cm

**2330**



89 cm

**2331**

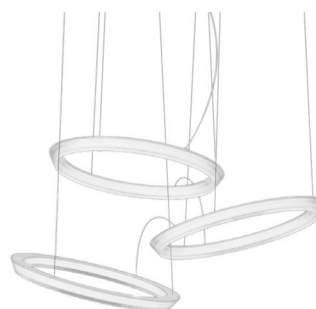

127 cm

**2332**



197 cm

**2333**

1160 10 /1A

Model Finish  
LED temperature colour Control

Each project is unique.  
Personalise your own  
Halo composition  
quick and easy.



# Halo Circular

**2330**

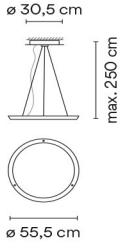

**Finishes**  
 ● **03/ \_\_ White**  
 (RAL 9016)

**LED temperature colour**  
 /2\_ 3000 K   
 CRI >80 1726,78 lm 75 lm/W

**Control**  
**2330 \_\_ / \_ 1**  
 DALI  
**2330 \_\_ / \_ 3**  
 1-10V  
**2330 \_\_ / \_ Z**  
 Casambi

**Materials**  
 Diffuser: PMMA. Canopy: Steel

**Light Source and electronics**  
 1 x LED STRIP 24V 23 W  
 Constant Voltage 24V  
 100~277V 50/60Hz

**Packaging**  
 1 Box 0,60 x 0,60 x 0,27 m  
 Vol 0,0972 m<sup>3</sup>  
 Gross weight 5,75 Kg Net weight 3,75 Kg



**2331**

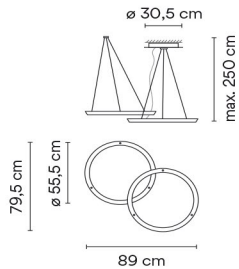

**Finishes**  
 ● **03/ \_\_ White**  
 (RAL 9016)

**LED temperature colour**  
 /2\_ 3000 K   
 CRI >80 3453,56 lm 75 lm/W

**Control**  
**2331 \_\_ / \_ 1**  
 DALI  
**2331 \_\_ / \_ 3**  
 1-10V  
**2331 \_\_ / \_ Z**  
 Casambi

**Materials**  
 Diffuser: PMMA. Canopy: Steel

**Light Source and electronics**  
 2 x LED STRIP 24V 23 W  
 Constant Voltage 24V  
 100~277V 50/60Hz

**Packaging**  
 1 Box 0,60 x 0,60 x 0,27 m  
 Vol 0,0972 m<sup>3</sup>  
 Gross weight 10,25 Kg Net weight 6,25 Kg



**2332**

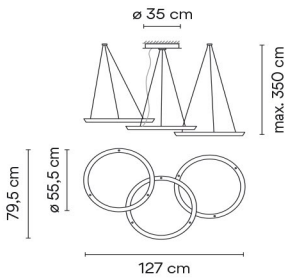

**Finishes**  
 ● **03/ \_\_ White**  
 (RAL 9016)

**LED temperature colour**  
 /2\_ 3000 K   
 CRI >80 5180,34 lm 75 lm/W

**Control**  
**2332 \_\_ / \_ 1**  
 DALI  
**2332 \_\_ / \_ 3**  
 1-10V  
**2332 \_\_ / \_ Z**  
 Casambi

**Materials**  
 Diffuser: PMMA. Canopy: Steel

**Light Source and electronics**  
 3 x LED STRIP 24V 23 W  
 Constant Voltage 24V  
 100~277V 50/60Hz

**Packaging**  
 1 Box 0,60 x 0,60 x 0,27 m  
 Vol 0,0972 m<sup>3</sup>  
 Gross weight 14,75 Kg Net weight 8,75 Kg



**2333**

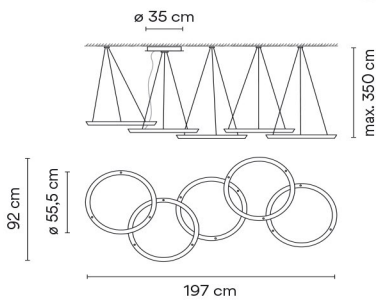

**Finishes**  
 ● **03/ \_\_ White**  
 (RAL 9016)

**LED temperature colour**  
 /2\_ 3000 K   
 CRI >80 8633,9 lm 75 lm/W

**Control**  
**2333 \_\_ / \_ 1**  
 DALI  
**2333 \_\_ / \_ 3**  
 1-10V  
**2333 \_\_ / \_ Z**  
 Casambi

**Materials**  
 Diffuser: PMMA. Canopy: Steel

**Light Source and electronics**  
 5 x LED STRIP 24V 23 W  
 Constant Voltage 24V  
 100~277V 50/60Hz

**Packaging**  
 2 Boxes  
 Total Vol 0,1106 m<sup>3</sup>  
 Gross weight 23,75 Kg Net weight 13,75 Kg



1160 10 /1A

Model

Finish

LED temperature colour

Control

